

James Walker[®]

How stem finish affects friction and fugitive emissions with graphite-based control valve packing

A technical paper
presented by
James Walker & Co Ltd
First presented at Valve World 2010





Mark Richardson
Product manager – compression packing

Mark Richardson currently holds the position of compression packing product manager for James Walker & Co. based in the North of England. He is responsible for global marketing, product and business development for the James Walker range of compression packing products.

He joined James Walker in 1997 and has held technical roles within the sealing industry for over 15 years. This included 6 years as a senior applications engineer, specialising in valve sealing and fugitive emission applications.

Mark graduated from Birmingham University with a BSc in Pure Physics.

HOW STEM FINISH AFFECTS FRICTION AND FUGITIVE EMISSIONS WITH GRAPHITE BASED CONTROL VALVE PACKING.

Abstract

In previous papers we have discussed how graphite based valve stem packing can be used in control valve applications. Benefits of using a graphite based packing include improved thermal stability, compared to traditional PTFE chevron seals though, there is a minor penalty of increased friction. However, whilst the PTFE seals have been widely used for many years, achieving reliable performance with graphite packing sets in high cycle duties requires a different approach to the boundary tribology between the packing and stem.

Further research into the effect this has on sealing performance and friction characteristics was required, as these were not well documented nor the effects well understood. The optimisation of the stem condition is required in order to achieve a desired high level of tightness, whilst minimising friction. A greater understanding of these factors, specifically in relation to control valve packing, would allow specification of a valve stem finish based on the sealing material and required performance.

This paper will discuss the equipment, test methods and results generated using the James Walker methane test facility that simulates a rising stem valve. Tests will be carried out on test stems with surface finishes ranging from polished chrome to a rough ground 2.6µm Ra. Effects of increased packing load and thermal cycling on leakage and friction will be investigated including the hypothesis that there is an optimum surface finish specific to a packing, which maximises performance of these two parameters.

The transfer of graphite and additional lubricants to a dynamic contact surfaces with different surface finishes and the effect this has on the leakage and pressure profiles will be discussed.

The test results for the James Walker proprietary grade of control valve packing will be compared to a conventional combination style of graphite based packing set.

Given the new understanding of the effect of stem surface finish on fugitive emissions, and frictional loads generated, consideration will also be given to how this influences the following issues:

- The longevity of graphite packing in control valve use over high cycle tests
- The production of successful test results to common valve fugitive emission specifications such as ISO15848 or Shell 77-312 as well as the API622 packing specification.

Introduction

A well designed and efficiently performing control valve can have a significant impact on process profitability, via reduced process costs, ecological factors and safety via fugitive emissions. We have previously reported that whilst control valves are perhaps only 5% of a refinery valve population; they are statistically twice as likely to be found leaking in an emission survey, as of course they are continually in operation and thus pose a greater problem than block valves.

A substantial component of the friction produced within a linear reciprocating or rotary control valve is generated by the valve stem sealing arrangement. Stem / Seal friction values are influenced by two main factors: materials, and specification driven FE targets. High gland loads used in an attempt to achieve low levels of leakage such as ISO15848, can produce excessive friction. This of course directly impacts on valve efficiency and dead band response, particularly with air driven cylinders. Graphite seals can generate excessive stick-slip friction producing highly unreliable valve performance. In a previous Valve World paper presented by James Walker & Co. Ltd, ref P4052, entitled 'Control Valves – The next Fugitive Emissions Challenge', it was shown that thermal cycling can severely affect the emissions performance of PTFE based packing. This is due to the high coefficient of thermal expansion and contraction of those seals.

Reducing the generated friction, and judder caused by a graphite based packing would allow the desirable attributes of performance under thermal cycling and constant operation to be combined. One way to achieve the required performance is to use high quality braided graphite based packing with an additional lubrication package and a suitable packing load.

Cost effectiveness, and resistance to corrosion are normal aspects considered during valve stem specification, influence on valve performance is not. Once a standard finish is specified this is applied across the valve range irrespective of sealing material and required fugitive emission performance. The use of graphite as a sealing element relies on the transference of graphite to the stem as a running surface. Little is known about how the stem surface finish affects the generation of this deposit and how this subsequently influences fugitive emission performance and friction.

1.0. Methodology

1.1. Test Apparatus

James Walker Rising Stem Fugitive Emissions Test Rig

Figure 1

1.1.1. Test rig description

The test rig consists of a simulated valve gland and housing enclosed within a thermal oil chamber. The stem is driven from above by an air cylinder. This produces a rising stem with interchangeable lower sections to allow testing of different stem diameters and materials. An externally operated oil heater can generate temperatures within the stuffing box from ambient to 200°C. A load cell situated in the stem arrangement generates continuous frictional load data. Load cell data as well as pressure and temperature are all continuously relayed to a PC.

The stem and housing sizes used throughout this test programme were $\frac{3}{4}$ " x $1\frac{1}{4}$ " x $\frac{1}{4}$ " (19.05mm x 21.75mm). A 5 ring packing set was fitted in the stuffing box. Load was applied via 2 x M12 socket head cap screws.

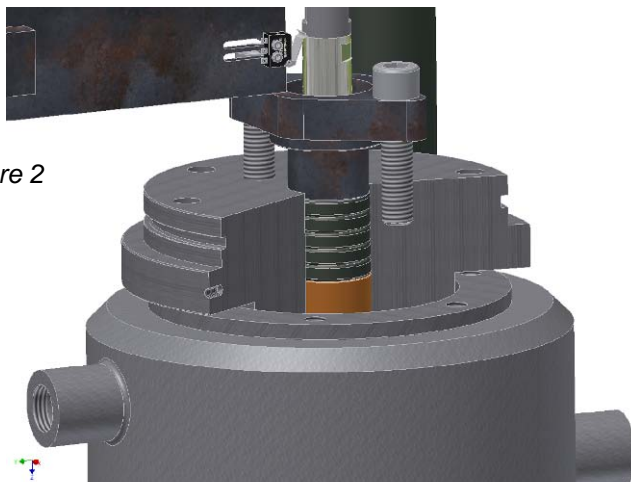

Figure 2

The rig normally operates at a full stem stroke of 50mm thus the stem fully passes through the packing set. However to simulate a control valve movement micro switches were added positioned on a plate adjacent to the stem. These can now be adjusted to produce a partial stem stroke. The speed of the stroke can also be adjusted by varying the air line pressure to the drive cylinder. Leakage was measured using a TVA-1000B Toxic Vapour Analyser and EPA Method 21.

1.2. Test Regime

The following graph depicts the temperature, pressure and cycle profile used as the basis for each test.

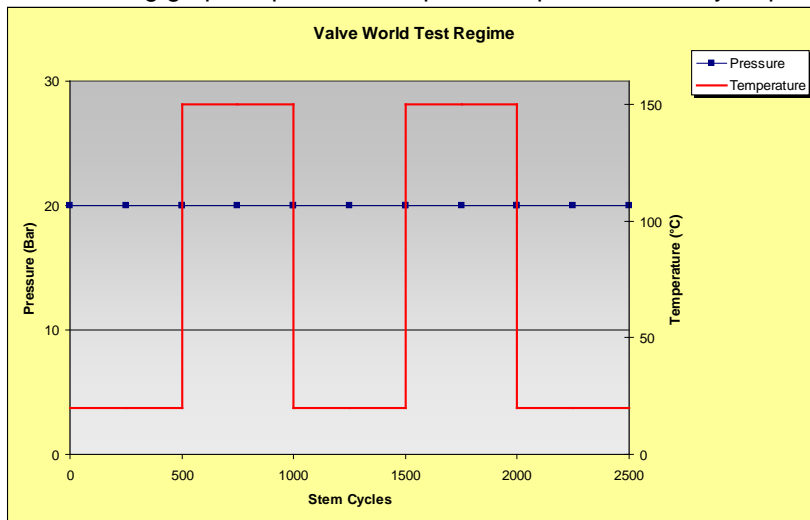

Figure 3

Number of Strokes (Cycles) – 2,500.

This was chosen as it was believed that there is little variation in performance in a longer cycle test. Whilst it is less than the CC1 level of 20,000 cycles in the ISO standard it is at least the same as the CO3 level and the inclusion of two thermal cycles were thought to be of more value than total endurance at this stage.

Temperature / Thermal Cycles

Two thermal cycles were carried out, as illustrated above, to a maximum temperature of 150°C

Pressure

20 bar pressure was used as this is nominally the pressure rating for an ASME class 150 valve at ambient temperature.

Leakage Measurement

Leakage was measured every 250 cycles.

Compression Packing

For the purposes of this test Supagraf[®] Control was used as the braided length form fugitive emission control valve packing.

1.3. Valve Stems / Surface Roughness

The valve stems tested were all of a ground finish to avoid any effects of leakage tracking along a turned surface finish (except chromed). 7 different surface finishes were tested, these are indicated below.

Stem Number	Nominal Surface Finish (µmRa)	Material / Manufacture
1	0.2	304 St./Steel, Ground
2	0.4	304 St./Steel, Ground
3	0.6	304 St./Steel, Ground
4	0.8	304 St./Steel, Ground
5	1.6	304 St./Steel, Ground
6	2.6	304 St./Steel, Ground
7	0.15 measured	Polished Hard Chrome Plated St/Steel 304

1.4. Test Method

The same installation / set up procedure was followed at the start of every test. The procedure was as follows:

- The packing was fitted in accordance with fitting instructions supplied with the packing
- Bolt threads and nuts were lubricated with a silicone lubricant prior to every test.
- 5 full stroke settling cycles were carried out, with the bolts being re-torqued at the top and bottom of each stroke.
- The stroke length of the stem was adjusted to be 10 ± 1 mm with a period of 3 to 6 seconds
- Methane pressure was maintained and adjusted 5 minutes prior to every measurement point to give 20 ± 1 bar

Values of the friction profile were taken at the beginning and end of each 2,500 cycle test. The data capture programme sampled load data 3200 times in 180 second period. A sampling frequency of 20 per second was used allowing comparison of the friction profile not just average and maximum values. The standard data capture programme samples once per second and records: time, pressure, packing temperature and stem load.

2.0. Results

2.1. Leakage

2.1.1. 35MPa Packing Stress

Figure 4 illustrates the Stem leakage from the valve when 35MPa stress is applied to the packing. The y axis is logarithmic; it therefore becomes obvious that the rougher stems 1.6 – 2.6 μ mRa produce significantly more leakage.

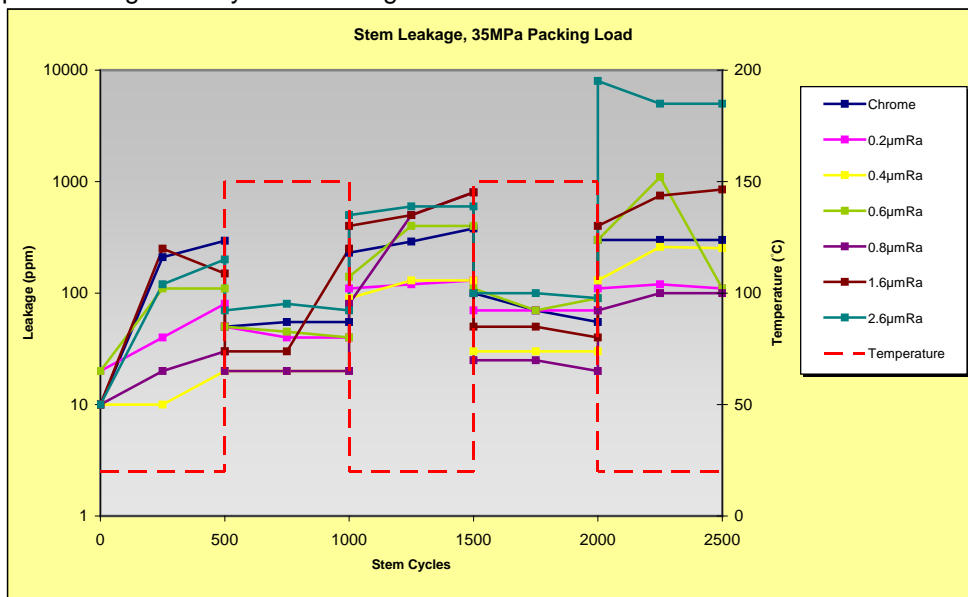

Figure 4

All surface finishes tested at this stress produced leakage in excess of 100ppm. As an approximation this could be roughly equivalent level to the ISO15848 Class B.

Figure 5 shows the average leakage against stem surface finish. The smoother stem finishes performed better with the best results obtained with 0.2 and 0.4µmRa stems.

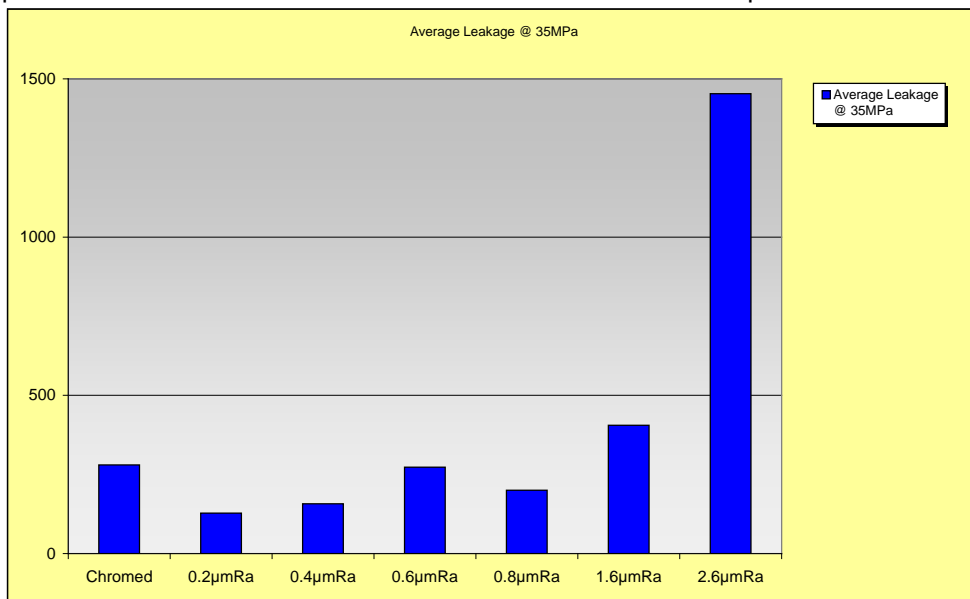

Figure 5

2.1.2. 70MPa Packing Stress

Figure 6 displays the 70MPa leakage results. Due to the overall lower leakage results a linear scale was used. These results show that smooth stems such as chromed and 0.2µmRa produce the highest leakage, this is the opposite of the result at 35MPa.

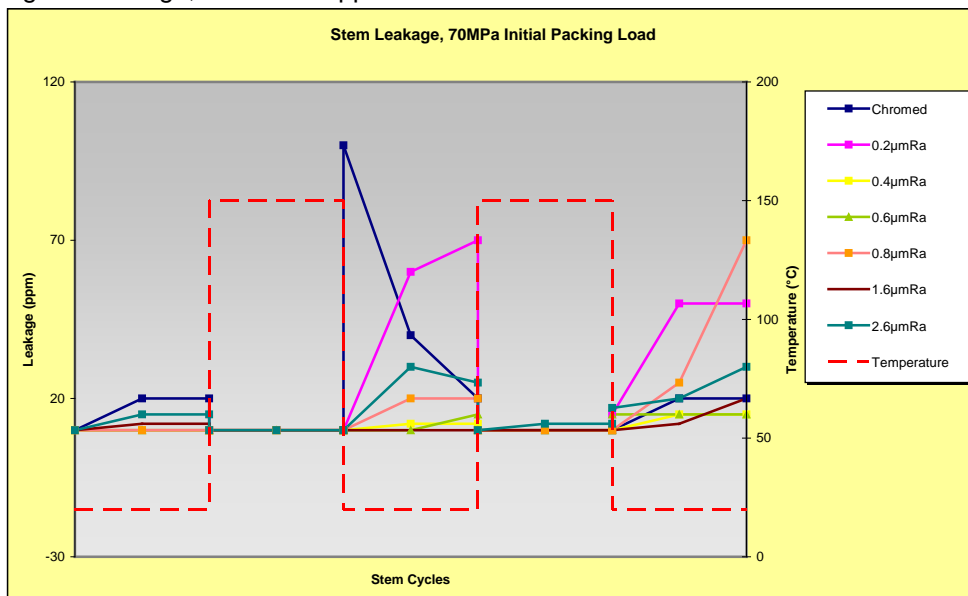

Figure 6

The performance of all surface finishes under the increased load has an order of magnitude improvement on leak tightness. The chrome finished stem generated the highest detected leakage level, at 110ppm during the second ambient temperature period, with all other leakage measurements were below the 100ppm threshold. This proves categorically that even with a high performance fugitive emission packing, significantly higher packing loads than might normally be applied to a valve packing, are required to achieve the ISO15848 levels of sealability.

At both stress levels tested the leakage reduces during the high temperature cycle. The leakage value typically increases with increasing number of thermal cycles. Several factors are likely to influence leakage at temperature, thermal expansion of metal work and housing, degradation of lubricants and transfer of a graphite running surface to the stem. Thermal expansion will be the major factor however the viscosity of additional lubricants or volatile compounds will decrease significantly at elevated temperatures.

Figure 7 shows the average leakage against stem surface finish at 70MPa. The best performance was obtained with 0.4 and 0.6µmRa stems. Note the different scale on the Y axis.

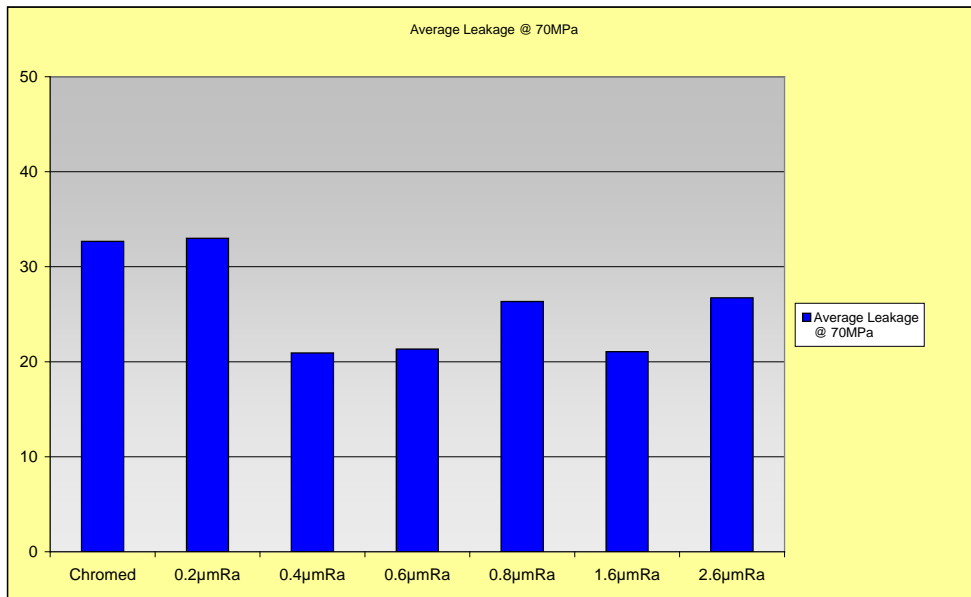

Figure 7

2.2. Frictional Load

2.2.1. Average Maximum Load

In order to easily compare results between different stem materials, the maximum and minimum frictional load values generated in an individual stroke were isolated and compared graphically. Individual stroke periods have been analysed separately and plotted as a single point at the end of the cycle; therefore a point plotted at 500 cycles covers the 0-500 cycle period.

Figure 8 shows the average positive load generated when a load of 35MPa is applied to the packing. The 2.6µmRa stem generates the highest load however this trend is not consistent with descending Ra values. The results generated with the lower packing stresses follow no specific pattern with respect to surface finish.

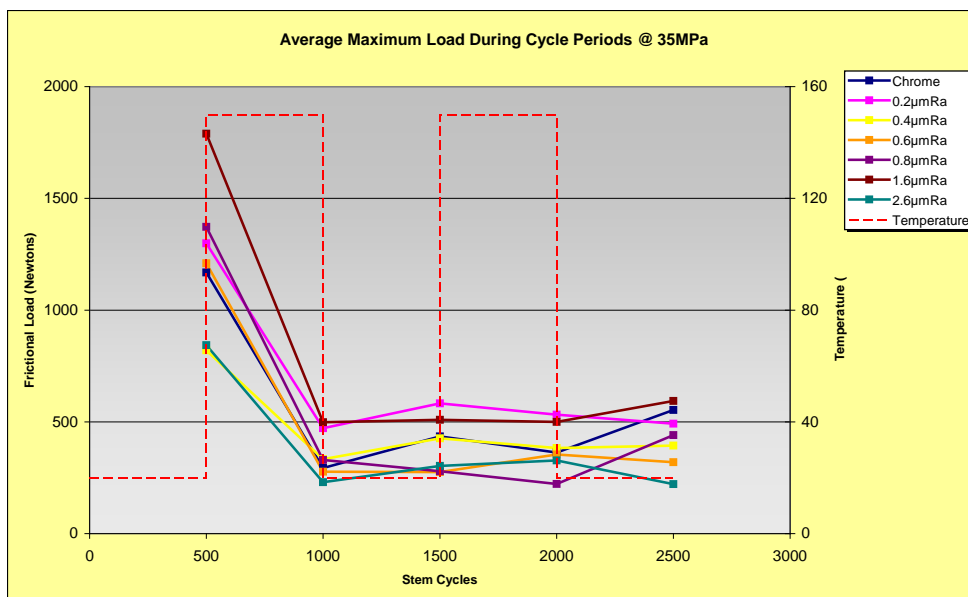

Figure 8

The average load decreases significantly after the first thermal cycle and remains consistent for the duration of the test. Calculating the load per circumferential length of the ID there is a 6.68N/mm

difference between the maximum and minimum values, for all tests, once the first thermal cycle is complete.

Figure 9 shows the average friction against stem surface finish. The lowest values are generated with the 0.6 and 0.8 μ mRa stem finishes.

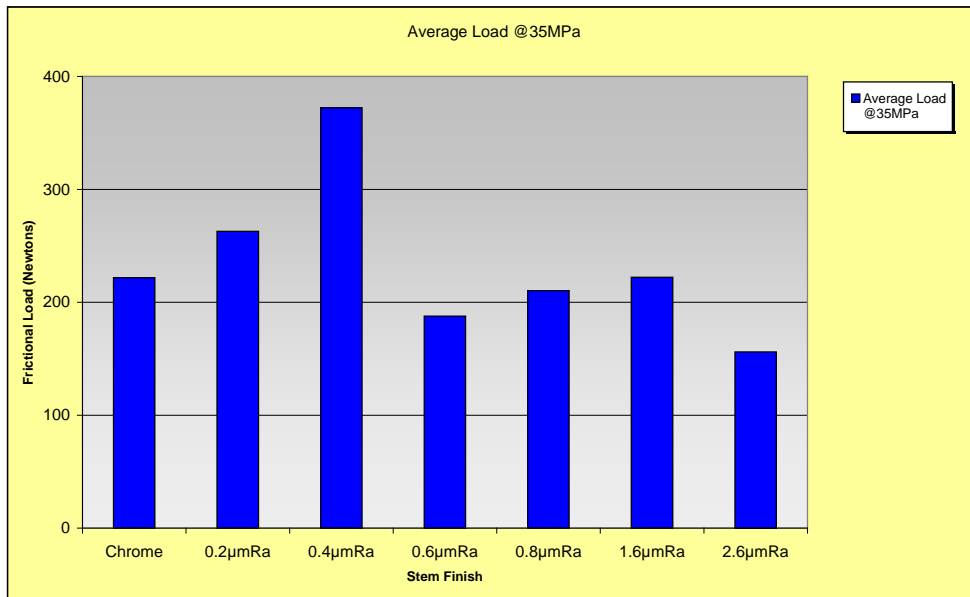

Figure 9

The results at 70MPa (Figure 10) are more consistent, with each result line following a similar profile. With the exception of Chromed and 0.2 μ mRa the results are very similar and suggest that there is less than 300N (5.02N/mm ID) between any result when stems 0.6 to 1.6 μ mRa are used.

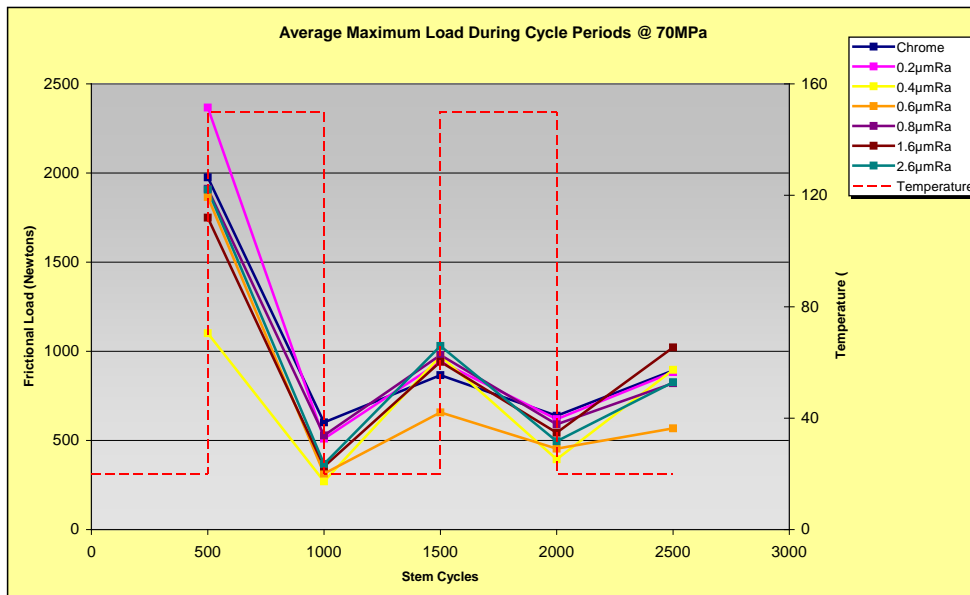

Figure 10

Figure 11 shows the average frictional load generated at 70MPa packing load against stem finish. Finishes 0.2 to 0.6µmRa generate the lowest friction with a pattern consistent with the temperature profile.

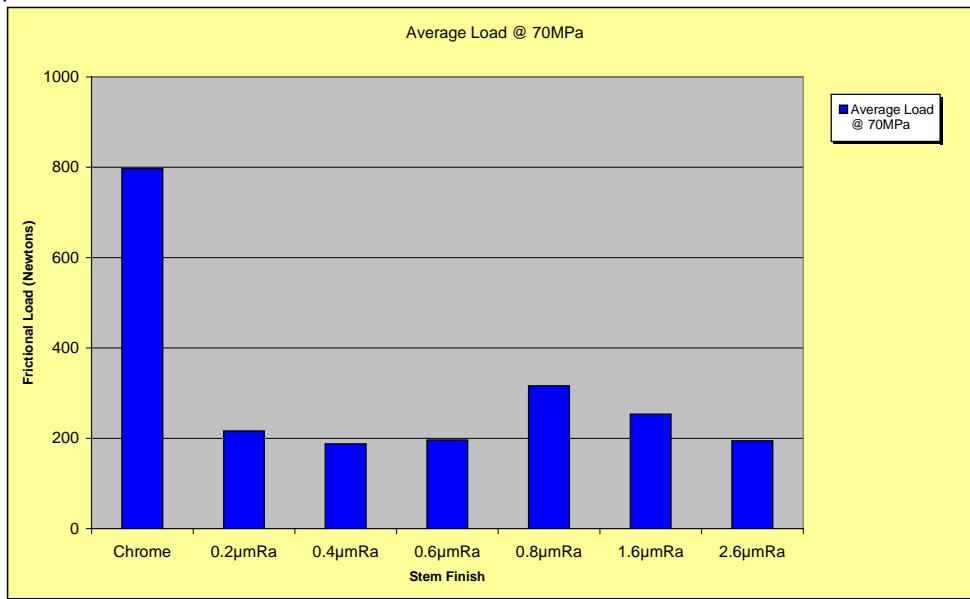

Figure 11

2.2.2. Variation in Maximum load during a Cycle Period

Variation in the value of maximum load during a cycle period can give an indication as to the 'smooth' low friction running of a valve stem. Stick-slip and judder are all common place on valves where the packing is generating high friction. Figures 9 and 10 show the variation in maximum loads measured during a cycle period. The greater the variation in maximum loads the more likely the packing and stem interface is producing inconsistent dynamic contact, 'stick-slip' and judder.

Results at 35MPa (Figure 12) show a large dispersion with a significant reduction after the first thermal cycle. Low surface roughness stems such as Chromed, 0.2, 0.4 and 0.6µmRa all show greater dispersion of frictional values than rougher 1.6 and 2.6µmRa.

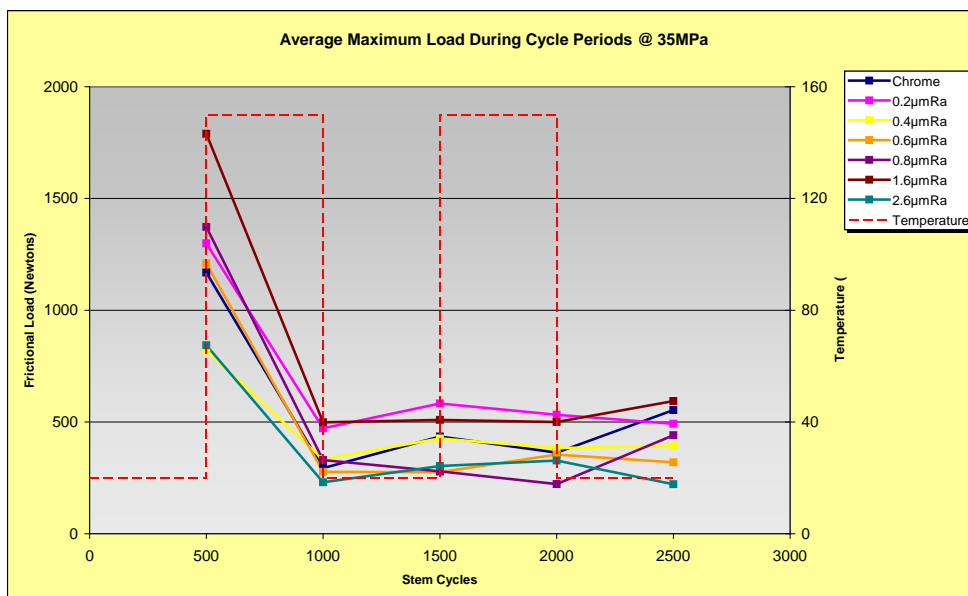

Figure 12

The use of 70MPa load (Figure13) produces large variances with stem finishes 2.6µmRa, chromed and 0.2µmRa. The results for chromed are particularly poor and unlike any other the variance widens significantly after the first thermal cycle. This suggests that if a lubrication film is developed it is unstable. Surface finishes such as 0.4 and 0.6µmRa produced consistently low variances, suggesting smooth, low friction performance.

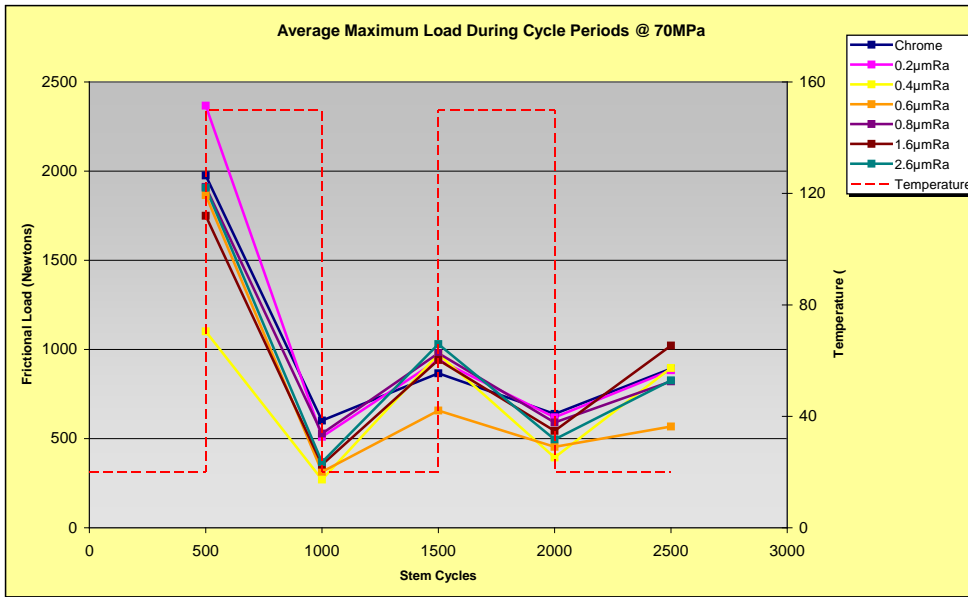

Figure 13

2.2.3. Trend in Maximum Load during a Cycle Period

Although the average load gives a specific value to compare between tests it gives no indication as to an increasing or decreasing trend within the stroke period. Figure 14 shows a typical 5 cycle period/Load graph. During the first ambient cycle there is an upward trend of maximum load value, the gradient of this line would give an indication as to the severity of this increase and allow comparison between tests to be made.

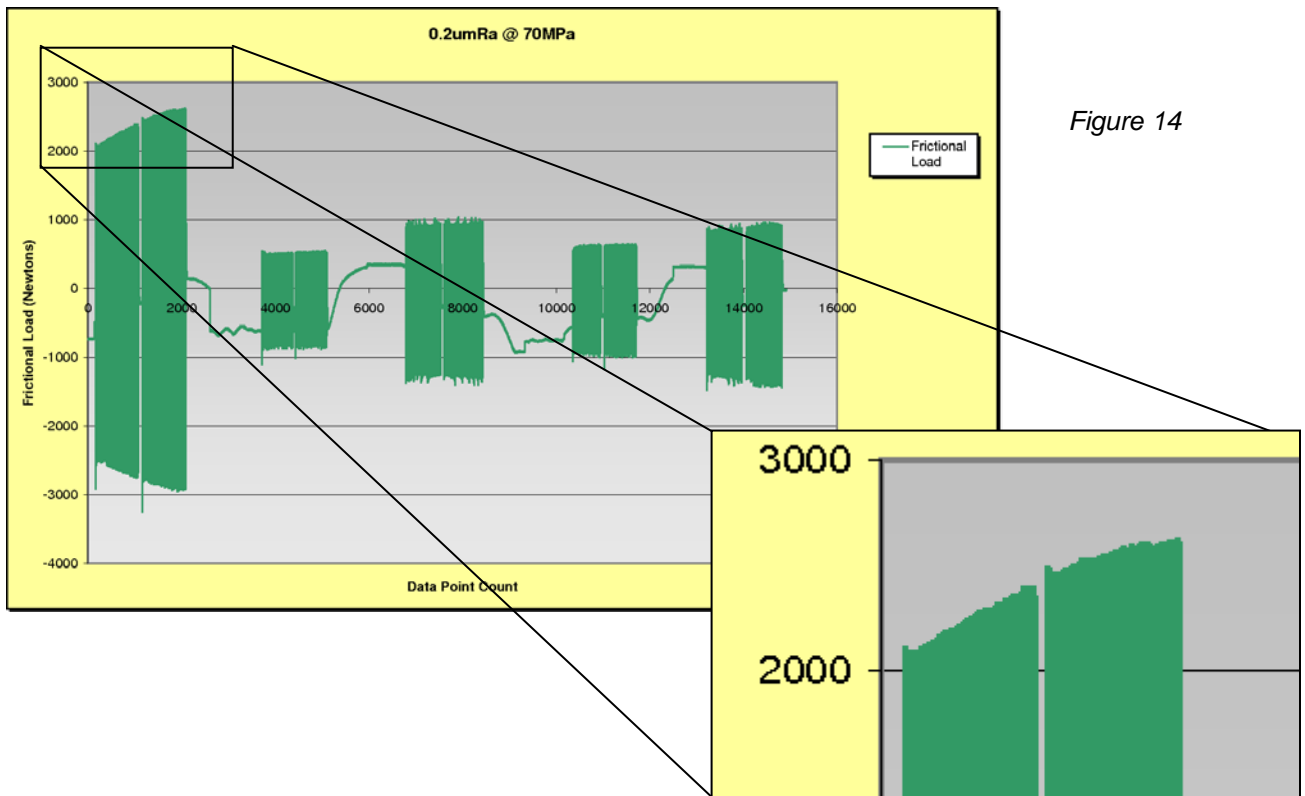

Figure 14

Analysis of the data showed that the only significant gradient was present in the first 500 cycles of tests carried out on stem finishes chromed and 0.2µmRa at a packing load of 70MPa.

2.2.4. Single Cycle Profile

Figures 15, 16 and 17 display a single frictional load profile taken at 0 and 2,500 cycles taken on stems 0.2, 0.6 and 2.6 μ mRa respectively. The results for 35MPa and 70MPa are displayed simultaneously

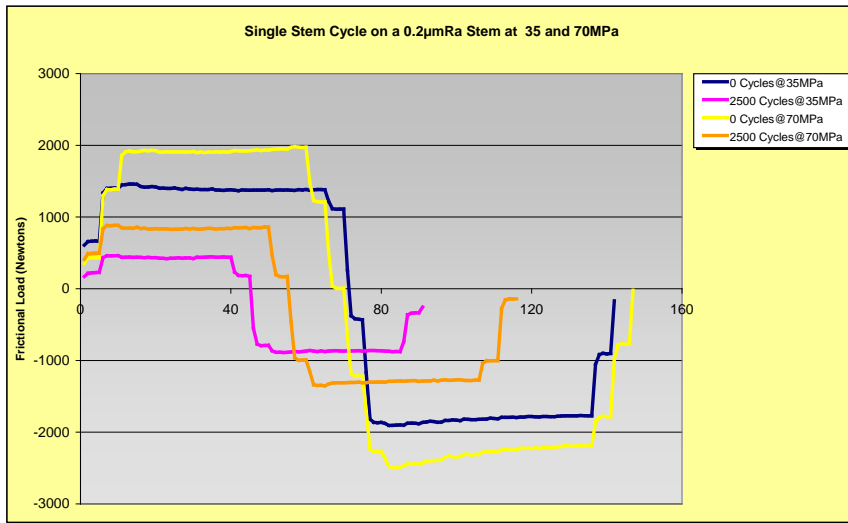

Figure 15

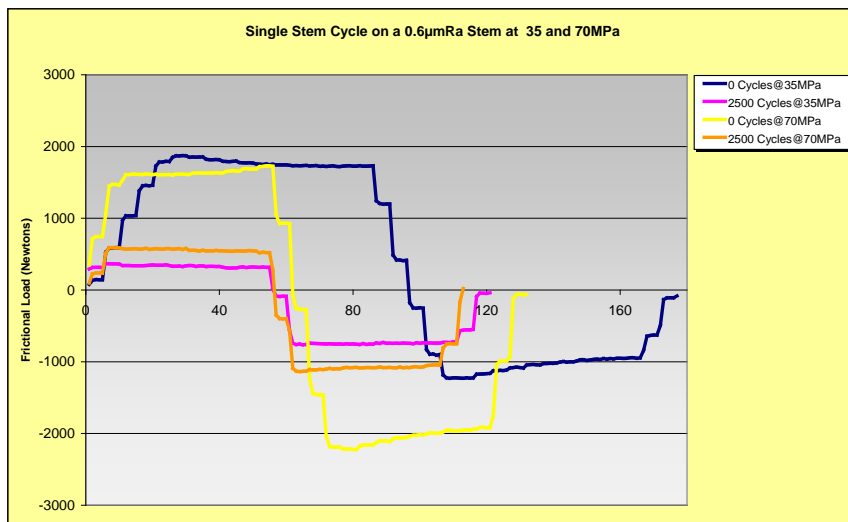

Figure 16

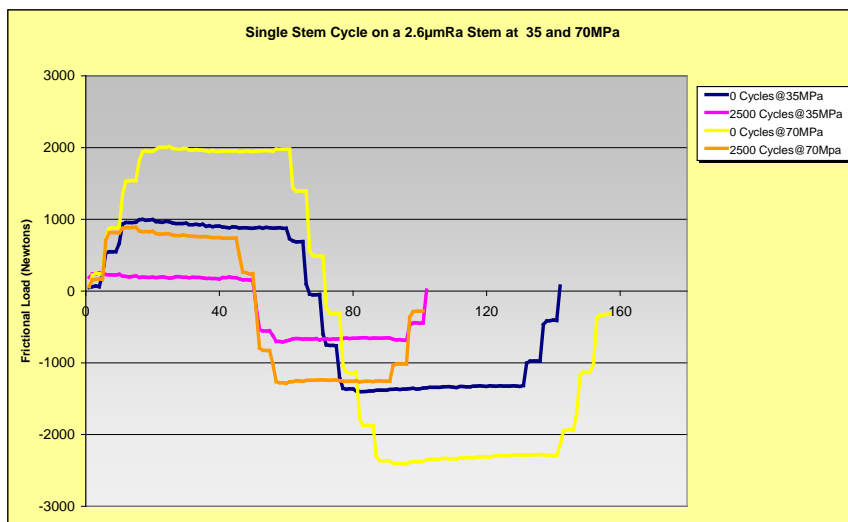

Figure 17

0.2 and 0.6 μ mRa profiles show a similar change from 0 cycles to 2,500 cycles independent of packing load. The result at 2.6 μ mRa however shows a dramatic % decrease with the test conducted at 70MPa. The initial 70MPa profile has a significantly larger frictional value than for 35MPa, this gap becomes reduced at smoother stem finishes with the result at 0.6 μ mRa giving a higher result for 35MPa than 70MPa

0.2 and 2.6 μ mRa graphs appear similar in profile during the period of maximum frictional load regardless of applied packing stress. The 0.6 μ mRa profile displays more variation during this period but again other than the maximum frictional load achieved, the profiles are similar.

The expected profile would be of an initial spike, to overcome breakout friction and inertia due to the direction change, followed by a slight decrease in the transition from static to dynamic friction. This is most evident on the 0.6 μ mRa profile, signifying that a better dynamic running surface has been achieved.

2.3. Comparison with a traditional “Combination” Graphite Packing Set

A single test was carried out on a combination packing set manufactured from materials that meet the Shell material specifications SPE85-203 and SPE85-204. This packing set consists of die-moulded expanded graphite intermediate rings, with braided carbon end rings. The test was carried out on a 0.4 μ mRa stem and results were compared with those obtained under the same conditions for the braided length form packing.

2.3.1. Leakage

The combination set performed poorly though out the test with leakage exceeding the 100ppm target after 500 Cycles. The introduction of a thermal cycle exasperated the leakage problem culminating in a total leakage of over 4,00ppm after 2,500 cycles. (Figure 18) This may also be attributable to the type and amount of lubrication package in the braided carbon end rings.

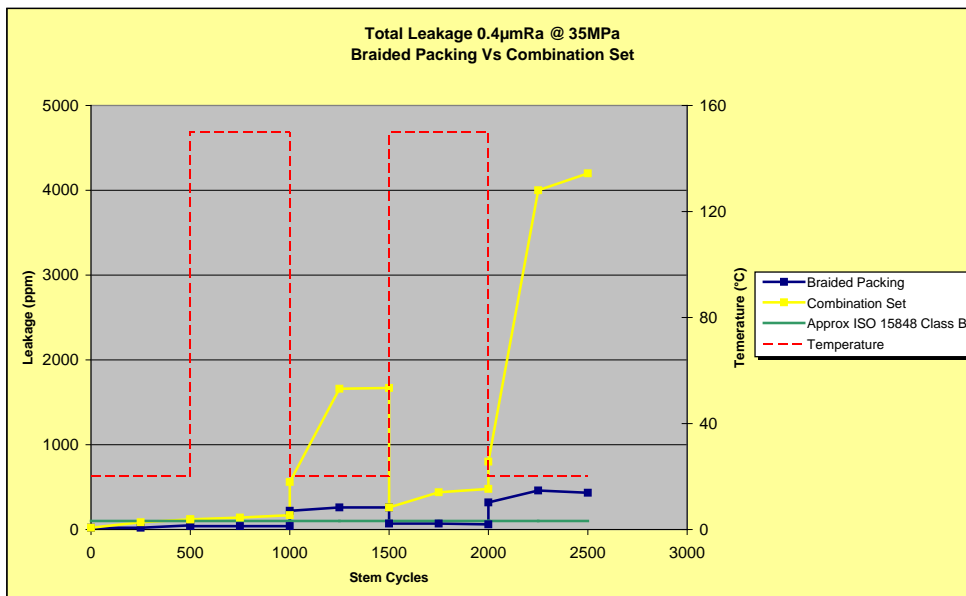

Figure 18

2.3.2. Frictional Loads

Figure 19 shows the average frictional load generated. All values generated were significantly greater than that for the braided length form packing. It must be commented that after 50 stem cycles a high pitched noise (squeak) could be heard coming from the stuffing box during stem movement.

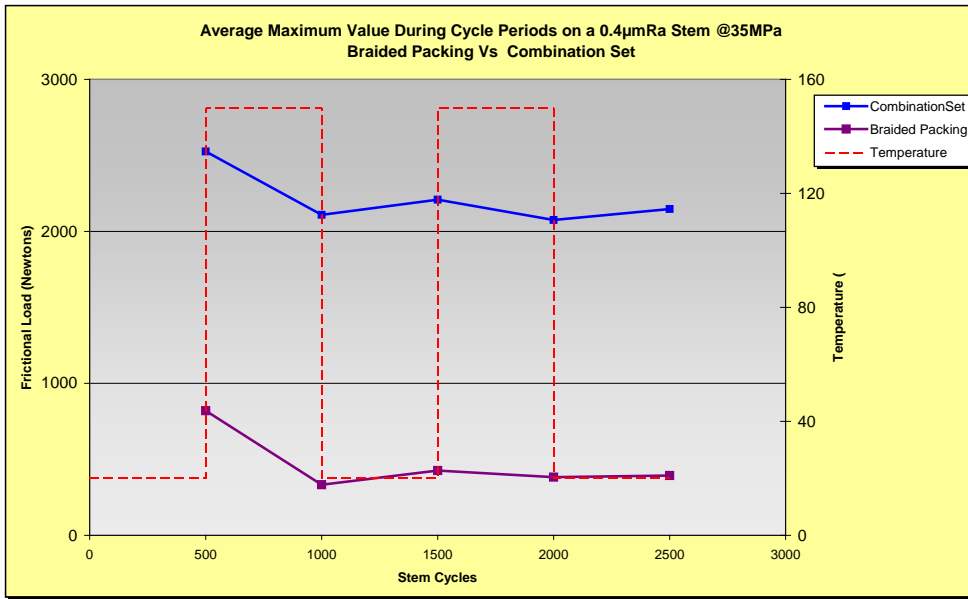

Figure 19

Figure 20 displays clearly that for the first 2,000 cycles smooth running was not achieved.

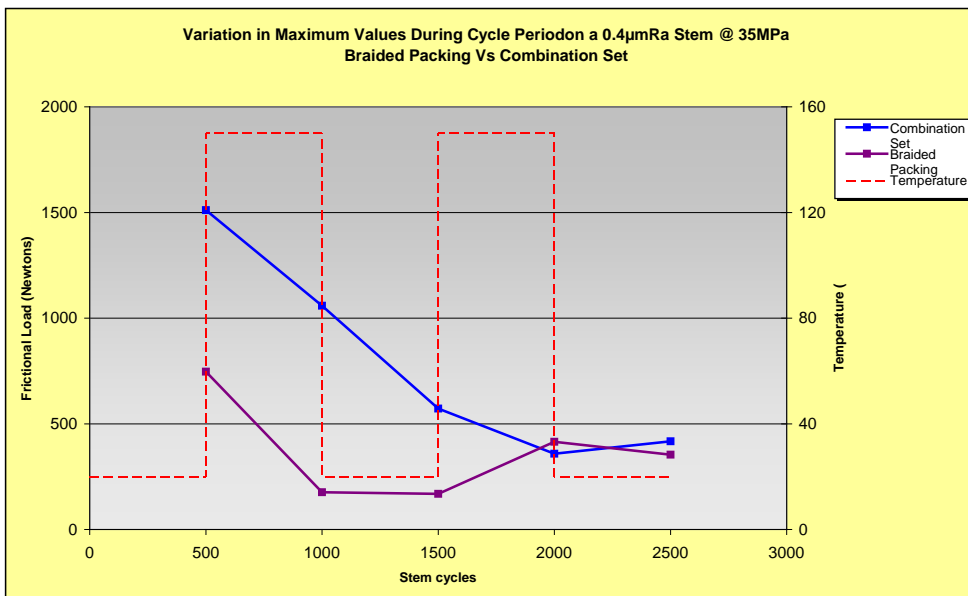

Figure 20

The same test was not carried out at 70MPa due to the anticipated strain and possible damage that would be placed on the actuator. For the purposes of this paper investigation into Combination set performance was terminated.

2.4. Graphite Deposit on Running Surface

The laminar nature of graphite allows the transfer to another surface in dynamic contact, the following images, (Figures 21 – 34), show the different transfer of graphite and lubricants to the stem with differing surface finishes.

Figure 21 -Chromed 35MPa



Figure 22 - Chromed 70MPa



Figure 23 - 0.2μmRa 35MPa



Figure 24 - 0.2μmRa 70MPa



Figure 25 - 0.4μmRa 35MPa

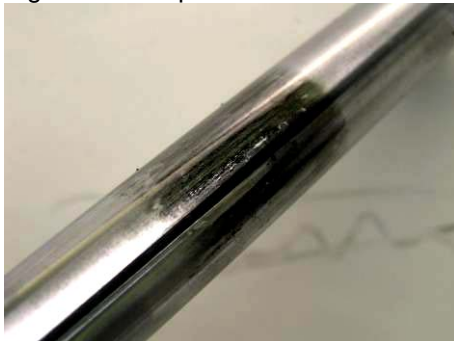

Figure 26 - 0.4μmRa 70MPa



Figure 27 - 0.6μmRa 35MPa



Figure 28 -0.6μmRa 70MPa



Figure 29 - 0.8 μ mRa 35MPa

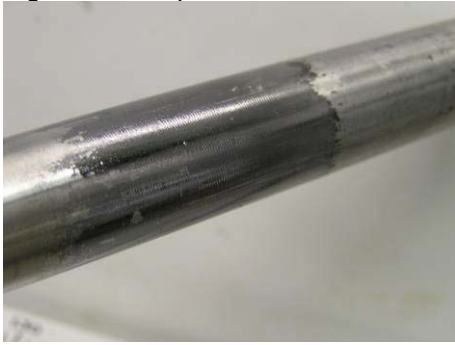

Figure 30 - 0.8 μ mRa 70MPa

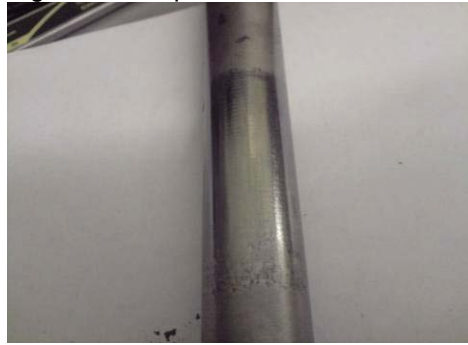

Figure 31 - 1.6 μ mRa 35MPa



Figure 32 - 1.6 μ mRa 70MPa



Figure 33 - 2.6 μ mRa 35MPa

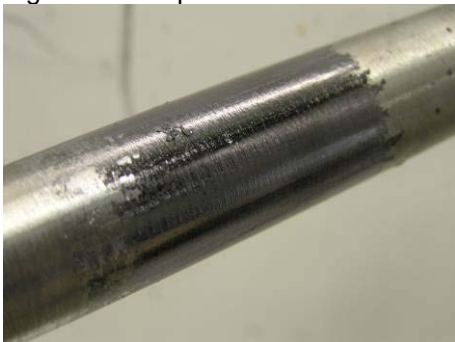

Figure 34 - 2.6 μ mRa 70MPa



The images show as would be expected, a larger amount of material deposited on the rougher finished stems than smooth, to the point where a chromed finish is unable to hold any substantial packing deposit. The magnitudes of these differences are increased with 70MPa packing stress.

3.0. Discussion points and future work

3.1. Friction

Friction within a system is dependant on several factors these include

- Surface area in contact
- Normal force on area
- Surface roughness
- Surface materials

For the purpose of these discussions we will presume that the surface area and materials remain constant.

At low levels of normal force the load applied to the surface is proportional to the frictional force produced. The initial 35MPa load applied generates radial movement and a normal load on the stem. Even though the majority of the radial movement occurred during the 0-35MPa loading period, increasing the load from 35 to 70MPa does not double the friction. Some densification of the packing

will take place at both 35 and 70MPa although the normal load per MPa rate is larger at 35 than 70MPa

Figures 9 and 11 show that although there is an effect of increased packing load on friction, the performance of a particular stem is influenced by the surface finish. Through previous testing it is the understanding of James Walker that graphite valve packing performs best when the transfer of material to the dynamic surface causes graphite to run on a deposited boundary layer (the grey coating seen on the images here) not graphite on steel. The thickness of deposit transferred to the stem will directly affect the initial friction and overall performance of the packing. This is a result substantiated by the average variation in maximum load value graphs. If there is insufficient depth to the surface topography then boundary materials cannot key to form the deposit. If there is too much depth then 'thick' graphite layers can form and flake off.

The results obtained at 35MPa show an element of chaos with no particular trend from smooth to rough. At 35MPa there may be insufficient load to form a consistent deposit along the full length of the stroke. Many of the images above show a broken and inconsistent lower edge and distinct upper edge to the deposit. The exponential decay of packing stress through a packing set from top to bottom will mean that the bulk of sealing and graphite deposit will be generated by the top 3 rings. Combine this with a short stroke length and the result is lower effective packing area in contact with the stem.

In all tests after the first thermal cycle the friction generated is lower. This would suggest that a change takes place, probably involving the packing and a deposit from the yarn dressing. Two possibilities could account for this phenomenon:

1. Supagraf Control is impregnated with a lubrication package that includes various boundary layer lubricants. These additional lubrication compounds flow at elevated temperatures and act either as a carrier for the graphite or coat the stem and make it easier for the graphite to then adhere.

At elevated temperatures these additives will have lower viscosity and therefore transfer with greater efficiency to another contact surface. The impregnation process during packing manufacture does force some lubrication package into the structure of the graphite but over 80% is deposited on the yarn surface. The additive then acts as a carrier for the graphite possibly making the more likely scenario that grease is deposited onto the metal, promoting graphite migration and adhesion to the grease.

2. Significant amounts of graphite are deposited on the stem during the first ambient strokes, which is then subsequently 'wiped' off at elevated temperature generating a more stable running surface.

The migration of the greases and additives onto the deposited graphite surface may breakdown this layer and allow graphite to be removed by the action of the packing against the stem

Future investigation with different purity rings and additive packages, though a temperature range would be required to substantiate any proposed theory.

3.1.1. Increasing Maximum Friction during first Ambient Cycle Period

An interesting point concerns the trend in maximum friction during the first ambient cycle period. A positive gradient was evident on chromed and 0.2µmRa stems at 70MPa packing load. The 4 factors that influence friction are; areas in contact, normal force, surface finish, and surface materials. Surface finish and materials all remain constant therefore normal load surface area could be increasing?

One possibility is that high levels of friction generated by poor adhesion of graphite to the stem cause a local temperature increase, creating expansion of the shaft or packing and increasing normal load. Further investigation is required to explain this observation; these tests would include continuing the ambient temperature cycle period to see if this trend reaches a maximum. Localised temperature

measurement and examining, at magnified levels, the surface treatment generated would be included in the investigation.

Another possibility is that the packing set continues to settle after the first 5 bedding in cycles. This settling may cause the normal force generated by the packing on the stem to be more evenly distributed through out the packing set. The maximum normal force may decrease but the area generating this force may increase, the net effect could be an increase in the total force.

3.1.2. Single Cycle Profile

The reduction in the overall friction profile for results at 0 cycles to 2,500 cycles prove that some boundary layer or running surface effect is occurring. The largest % decrease from 0 to 2,500 cycles took place on the 2.6µmRa at 70MPa. The 2.6µmRa surface finish has the deepest surface topography and therefore would generate the largest friction values on initial start up. The transfer of boundary lubricants and graphite would 'fill in' the peaks and troughs and effectively produce a smoother running surface. The effect of this 'filling in' process would be most evident on the 2.6µmRa surface finish.

The profile generated was not as expected. A prediction of the friction profile would include a definite spike, representing breakout friction and then a decreasing curve as you transfer from static to dynamic friction. There was some evidence of this initial spike with a small reduction in friction. To achieve a true breakout friction value the drive load would have to be increased slowly until the peak value was achieved. This slow ramp up of drive force was not possible with the current equipment. Within this test regime the drive force is applied and ramps up quickly, this would have the effect of flattening off the friction profile as seen in the results. Breakout friction would have a significant influence on response time of a control valve. Further investigation is required with a reduced number of cycles, a higher sampling rate and different drive force profile.

3.2. Leakage

3.2.1. 35MPa and 70MPa

A significant improvement is seen in the fugitive emission performance of the packing tested when the packing load was increased to 70MPa. It is thought that the increased load will have a two fold effect on the performance of the packing:

1. Increased packing load settles and increases the density of the packing therefore closing voids and leak paths

Experience has proven that increasing the packing stress to a value between 50 and 70MPa dramatically improves the FE performance. This is the case with a combination set, moulded ring or length form packing. This has significant impact on valve design including:

- Increased Gland follower length – Increased compression on packing produces an extra 20% compression on a 5 ring packing set
 - Increased Bolting – Many valve are not designed to generate 70MPa of packing load; consideration must be given to bolt materials and yield stress
 - Fitting Instructions – A bolt load used to validate a valve to a particular specification must then be used routinely on packing fitting. The method of applying the bolt load and how accurately this is done must be considered.
2. Produces a larger normal force on the valve stem, producing a more uniform lubrication/graphite deposit

All results generated at 70MPa were more directly influenced by stem finish than those at 35MPa. At 70MPa any issues with forcing lubrication/graphite into the topography of a valve stem are overcome. This question then becomes "what quality of deposit is achieved" not "can it be achieved". Issues relating to the deposit of lubrication/graphite on a smooth surface finishes cannot be overcome using increased load and therefore these results become noticeably poorer.

3.2.2. Combination Set

The performance of the combination set was significantly worse both in terms of leakage and friction than the braided packing tested under the same conditions. Given that the stroke length was smaller than the overall length of the packing set the intent of the end rings become ineffective. The use of this type of packing on short stroke valve applications must be questioned.

3.3. Optimised Stem Finish and Load

3.3.1. Leakage levels > 100ppm

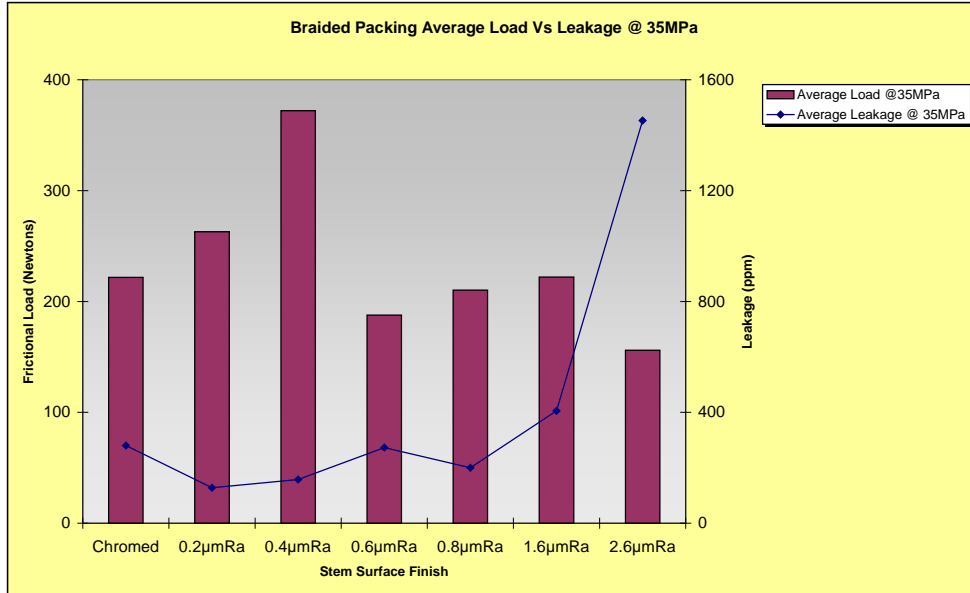

Figure 35

Gland loads of 35MPa produced leakage levels outside of that associated with ISO15848 however values below 1000ppm can still be achieved. The smooth stems chromed; 0.2 and 0.4µmRa produce the lowest average leakage. This result is opposite to that for friction as rougher stems, 0.6µmRa to 2.6µmRa, produce lower results.

It is therefore not possible using the packing type tested here to achieve lowest leakage and friction simultaneously with a single surface finish. A compromise giving the best balance of results is produced with 0.6µmRa.

3.3.2. Leakage levels < 100ppm

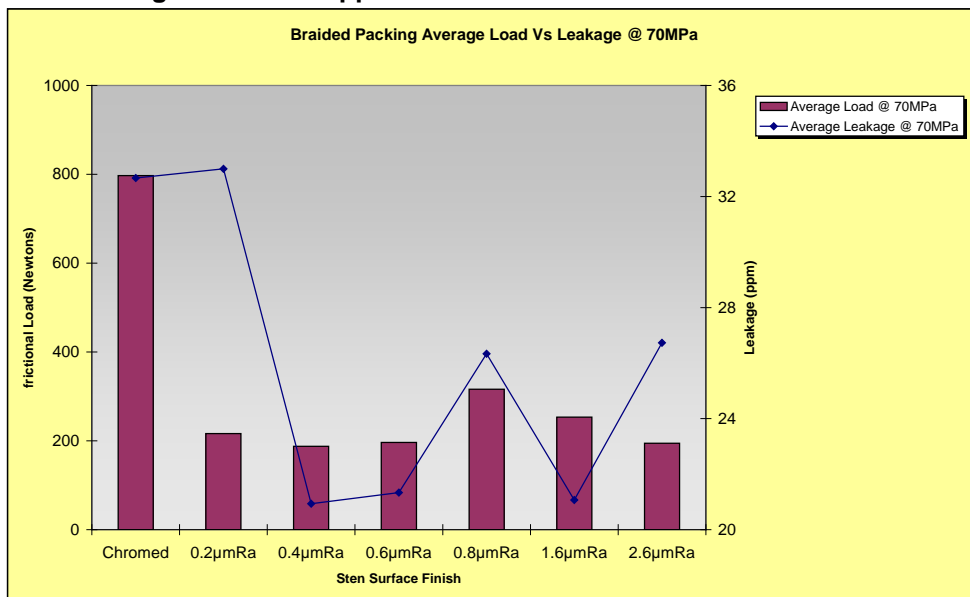

Figure 36

To achieve a total leakage of less than 100ppm the higher load of 70MPa was required. The lowest average leakage at 70MPa occurred on finishes 0.2, 0.4, and 0.6 μ mRa. The lowest average frictional loads combined with the least variation in maximum result occurred on finishes 0.4 μ mRa and 0.6 μ mRa.

Best results for both friction and leakage can therefore be generated using a surface finish of 0.4 μ mRa - 0.6 μ mRa.

3.4. Measurement of Stem Surface Finish

Shafts used in this series of tests were specified using nominal Ra values, this, I understand, is industry typical. It is possible to measure other parameters using current equipment that may provide better correlation between surface texture and friction/leakage results. These include:

- Ra_{max} – Maximum Ra value from sampled data
- Rz – Greatest height of the roughness profile
- Rz_{max} – Largest of the Rz values within the sample data
- Rt – Total height of the roughness profile
- Rmr(c) – Material component of the profile

4.0. Conclusion

The objective of this paper was to investigate the performance of the braided length form packing against different valve stem surface finishes and determine a surface finish that optimises leakage and friction parameters. This was successfully completed with the following results.

- **35MPa Packing Stress, Optimum result obtained with 0.6 μ mRa surface finish**
- **70MPa Packing Stress, Optimum results obtained with 0.4-0.6 μ mRa surface finish**

Other objectives included

- Investigate difference in performance between a braided length form packing and a combination set manufactured from materials that meets Shell SPE 85-203 and 85-204
- How results influence likely attainment of positive results when tested against specifications such as ISO1548, Shell 77-312 and SPI622.

A brief summary of the principle observations and conclusions drawn out from the test results are:

- Increasing packing stress from 35MPa to 70MPa does not produce a proportional increase in frictional load.
- Results for leakage and friction display no predictable pattern with a packing load of 35MPa
- At 70MPa the results are more regular and show a direct correlation with surface finish.
- The target leakage level of 100ppm was only achieved when a packing load of 70MPa was used.
- The introduction of a thermal cycle produces reduced friction values during subsequent stem cycles. Lubricant greases and other compounds when heated have reduced viscosity and influence the formation of a deposit onto the stem.
- Chromed and 0.2 μ mRa surface finishes produce an increasing maximum friction value during the first ambient cycle. The mechanism for this requires further investigation but it is believed to be attributed to settling within the packing or localised temperature increase.

- The combination set produced leakage and frictional loads significantly higher than the braided length form packing when tested under the same conditions. The short stroke length and use of graphite without additional lubrication were believed to be the cause.
- The results show that if the optimised stem and packing stresses are used the leakage and friction results are consistent through 2,500 cycles. Nothing within the observations suggests that this performance would deteriorate with an increased cycle count.

Further work is required to isolate which parameter of surface topography that if better defined could be used to push the performance envelope of graphite based fugitive emission packing.

James Walker worldwide sales and customer support

James Walker Asia Pacific

Tel: +65 6777 9896
Fax: +65 6777 6102
Email: sales.sg@jameswalker.biz

James Walker Australia

Tel: +61 (0)2 9721 9500
Fax: +61 (0)2 9721 9580
Email: sales.au@jameswalker.biz

James Walker Benelux

(Belgium)
Tel: +32 3 820 7900
Fax: +32 3 828 5484
Email: sales.be@jameswalker.biz

(Netherlands)

Tel: +31 (0)186 633111
Fax: +31 (0)186 633110
Email: sales.nl@jameswalker.biz

James Walker Brasil

Tel: +55 11 4392 7360
Fax: +55 11 4392 5976
Email: sales.br@jameswalker.biz

James Walker China

Tel: +86 21 6876 9351
Fax: +86 21 6876 9352
Email: sales.cn@jameswalker.biz

James Walker Deutschland

Tel: +49 (0)40 386 0810
Fax: +49 (0)40 389 3230
Email: sales.de@jameswalker.biz

James Walker France

Tel: +33 (0)437 497 480
Fax: +33 (0)437 497 483
Email: sales.fr@jameswalker.biz

James Walker Iberica

Tel: +34 94 447 0099
Fax: +34 94 447 1077
Email: sales.es@jameswalker.biz

James Walker Inmarco (India)

Tel: +91 (0)22 4080 8080
Fax: +91 (0)22 2859 6220
Email: info@jwinmarco.com

James Walker Ireland

Tel: +353 (0)21 432 3626
Fax: +353 (0)21 432 3623
Email: sales.ie@jameswalker.biz

James Walker Italiana

Tel: +39 02 257 8308
Fax: +39 02 263 00487
Email: sales.it@jameswalker.biz

James Walker Mfg (USA)

Tel: +1 708 754 4020
Fax: +1 708 754 4058
Email: sales.jwmfg.us@jameswalker.biz

James Walker New Zealand

Tel: +64 (0)9 272 1599
Fax: +64 (0)9 272 3061
Email: sales.nz@jameswalker.biz

James Walker Norge

Tel: +47 22 706800
Fax: +47 22 706801
Email: sales.no@jameswalker.biz

James Walker Oil & Gas (USA)

Tel: +1 281 875 0002
Fax: +1 281 875 0188
Email: oilandgas@jameswalker.biz

James Walker South Africa

Tel: +27 (0)31 304 0770
Fax: +27 (0)31 304 0791
Email: sales.za@jameswalker.biz

James Walker UK

Tel: +44 (0)1270 536000
Fax: +44 (0)1270 536100
Email: sales.uk@jameswalker.biz

This work is protected by copyright laws and treaties around the world. All such rights are reserved. © James Walker 2012

You may print off one copy, and may download extracts, of any page(s) from our site for your personal reference and you may draw the attention of others within your organisation to material posted on our site. You must not modify the paper or digital copies of any materials you have printed off or downloaded in any way, and you must not use any illustrations, photographs, video or audio sequences or any graphics separately from any accompanying text. You must not use any part of the materials on our site for commercial purposes without obtaining a licence to do so from us or our licensors.

Our status (and that of any identified contributors) as the authors of material on our site must always be acknowledged.

This information is based on our general experience, but because of factors which are outside our knowledge and control, no warranty is given or is to be implied with respect to such information. If any doubt exists, please seek advice from James Walker.